

# BORING

## BORING & DRILLING BITS

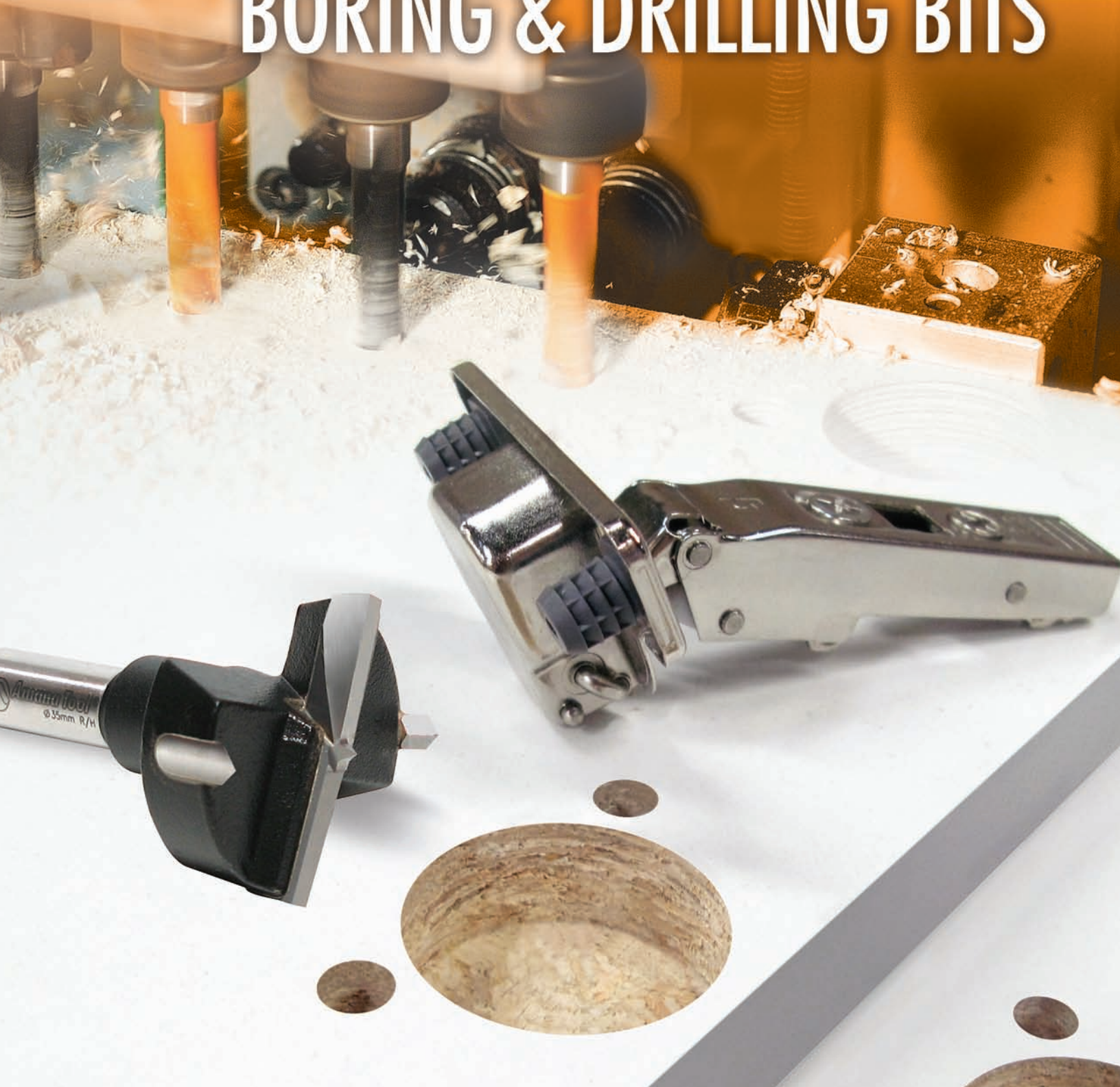

# Boring/Drilling

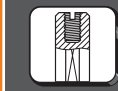

Automatic Boring Machines



Multi-Purpose Boring



Mortising & Slot Cutting



Countersinks/Counterbores

## †BRAD POINT BORING

### 57mm LONG, 10mm X 27mm SHANK

ØD	B	Tool No.- RH	Tool No.- LH	Ød	L
3mm	18mm	*201003	*301003	10mm	57mm
3.2mm	27mm	201032	301032	10mm	57mm
4mm	27mm	201004	301004	10mm	57mm
4.5mm	27mm	201045	301045	10mm	57mm
5mm	27mm	201005	301005	10mm	57mm
5.1mm	27mm	201051	301051	10mm	57mm
5.2mm	27mm	201052	301052	10mm	57mm
5.5mm	27mm	201055	301055	10mm	57mm
6mm	27mm	201006	301006	10mm	57mm
6.5mm	27mm	201065	301065	10mm	57mm
6.7mm	27mm	201067	301067	10mm	57mm
7mm	27mm	201070	301070	10mm	57mm
<i>New</i> 7.5mm	27mm	201075	301075	10mm	57mm
8mm	27mm	201008	301008	10mm	57mm
8.2mm	27mm	201082	301082	10mm	57mm
9mm	27mm	201090	301090	10mm	57mm
10mm	27mm	201010	301010	10mm	57mm
10.5mm	27mm	201105	301105	10mm	57mm
11mm	27mm	201011	301011	10mm	57mm
12mm	27mm	201012	301012	10mm	57mm
14mm	27mm	201014	301014	10mm	57mm
15mm	27mm	201015	301015	10mm	57mm
16mm	27mm	201016	301016	10mm	57mm
17mm	27mm	201017	301017	10mm	57mm
18mm	27mm	201018	301018	10mm	57mm
19mm	27mm	201019	301019	10mm	57mm
20mm	27mm	201020	301020	10mm	57mm
3/16	27mm	201047	301047	10mm	57mm
1/4	27mm	201007	301007	10mm	57mm
3/8	27mm	201009	301009	10mm	57mm
1/2	27mm	201013	301013	10mm	57mm

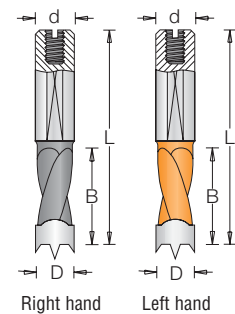
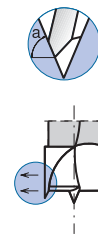

BORING/DRILLING

### 70mm LONG, 10mm X 35mm SHANK

3mm	18mm	*204003	*304003	10mm	70mm
3.2mm	35mm	204032	304032	10mm	70mm
4mm	35mm	204004	304004	10mm	70mm
4.5mm	35mm	204045	304045	10mm	70mm
5mm	35mm	204005	304005	10mm	70mm
5.1mm	35mm	204051	304051	10mm	70mm
5.2mm	35mm	204052	304052	10mm	70mm
5.5mm	35mm	204055	304055	10mm	70mm
6mm	35mm	204006	304006	10mm	70mm
6.5mm	35mm	204065	304065	10mm	70mm
6.7mm	35mm	204067	304067	10mm	70mm
7mm	35mm	204070	304070	10mm	70mm
7.5mm	35mm	204075	304075	10mm	70mm
8mm	35mm	204008	304008	10mm	70mm
8.2mm	35mm	204082	304082	10mm	70mm
9mm	35mm	204090	304090	10mm	70mm
10mm	35mm	204010	304100	10mm	70mm
11mm	35mm	204011	304011	10mm	70mm
12mm	35mm	204012	304012	10mm	70mm
13mm	35mm	204130	304130	10mm	70mm
14mm	35mm	204014	304014	10mm	70mm
15mm	35mm	204015	304015	10mm	70mm
16mm	35mm	204016	304016	10mm	70mm
17mm	35mm	204017	304017	10mm	70mm
3/16	35mm	204047	304047	10mm	70mm
1/4	35mm	204007	304007	10mm	70mm
3/8	35mm	204009	304009	10mm	70mm
7/16	35mm	204111	304111	10mm	70mm
1/2	35mm	204013	304013	10mm	70mm
5/8	35mm	204113	304113	10mm	70mm

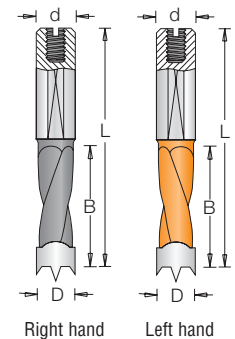

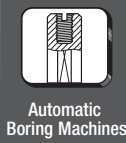

Automatic Boring Machines



Multi-Purpose Boring



Mortising & Slot Cutting



Countersinks/Counterbores

# Boring/Drilling



## †BRAD POINT BORING

77mm LONG, 10mm X 44mm SHANK

ØD	B	Tool No.- RH	Tool No.- LH	Ød	L
4mm	44mm	202004	302004	10mm	77mm
5mm	44mm	202005	302005	10mm	77mm
5.1mm	44mm	202051	302051	10mm	77mm
5.2mm	44mm	202052	302052	10mm	77mm
6mm	44mm	202006	302006	10mm	77mm
7mm	44mm	202070	302070	10mm	77mm
8mm	44mm	202008	302008	10mm	77mm
8.2mm	44mm	202082	302082	10mm	77mm
9mm	44mm	202090	302090	10mm	77mm
10mm	44mm	202010	302100	10mm	77mm
11mm	44mm	202011	302011	10mm	77mm
12mm	44mm	202012	302012	10mm	77mm

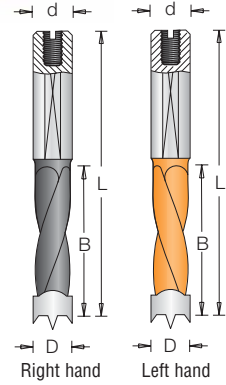

## †THROUGH-HOLE ('V' POINT)

57mm LONG, 10mm X 25mm SHANK

ØD	B	Tool No.- RH	Tool No.- LH	Ød	L
4mm	25mm	313004	413004	10mm	57mm
5mm	25mm	313005	413005	10mm	57mm
6mm	25mm	313006	413006	10mm	57mm
7mm	25mm	313070	413070	10mm	57mm
8mm	25mm	313008	413008	10mm	57mm
9mm	25mm	313090	413090	10mm	57mm
10mm	25mm	313010	413010	10mm	57mm
12mm	25mm	313012	413012	10mm	57mm
1/4	25mm	313007	413007	10mm	57mm
3/8	25mm	313009	413009	10mm	57mm
1/2	25mm	313013	413013	10mm	57mm

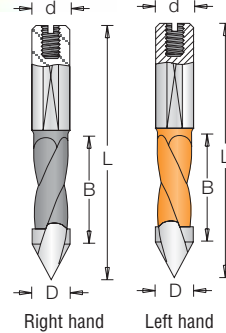

70mm LONG, 10mm X 40mm SHANK

ØD	B	Tool No.- RH	Tool No.- LH	Ød	L
4mm	40mm	314004	414004	10mm	70mm
5mm	40mm	314005	414005	10mm	70mm
5.5mm	40mm	314055	414055	10mm	70mm
6mm	40mm	314006	414006	10mm	70mm
7mm	40mm	314070	414070	10mm	70mm
8mm	40mm	314008	414008	10mm	70mm
9mm	40mm	314090	414090	10mm	70mm
10mm	40mm	314010	414010	10mm	70mm
11mm	40mm	314011	414011	10mm	70mm
12mm	40mm	314012	414012	10mm	70mm
14mm	40mm	314014	414014	10mm	70mm
16mm	40mm	314016	414016	10mm	70mm
3/16	40mm	314047	414047	10mm	70mm
1/4	40mm	314007	414007	10mm	70mm
9/32	40mm	314281	414281	10mm	70mm
21/64	40mm	314833	414833	10mm	70mm
11/32	40mm	314343	414343	10mm	70mm
3/8	40mm	314009	414009	10mm	70mm
7/16	40mm	314111	414111	10mm	70mm
1/2	40mm	314013	414013	10mm	70mm
5/8	40mm	314113	414113	10mm	70mm

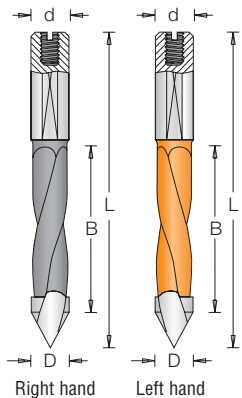

† Application: Not to be used in portable drills or handheld routers.

Wood profiles shown at actual size. 3D renderings & tool illustrations not shown at actual size.



# Boring/Drilling

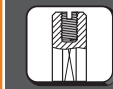

Automatic Boring Machines

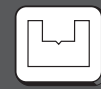

Multi-Purpose Boring



Mortising & Slot Cutting



Countersinks/Counterbores

## † THROUGH-HOLE ('V' POINT)

77mm LONG, 10mm X 45mm SHANK

ØD	B	Tool No. - RH	Tool No. - LH	Ød	L
5mm	45mm	315005	415005	10mm	77mm
6mm	45mm	315006	415006	10mm	77mm
7mm	45mm	315070	415070	10mm	77mm
8mm	45mm	315008	415008	10mm	77mm
9mm	45mm	315090	415090	10mm	77mm
10mm	45mm	315010	415010	10mm	77mm

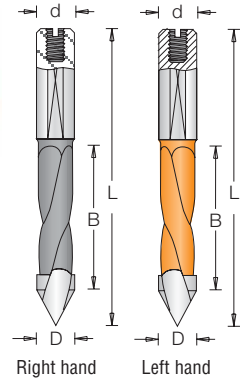

## † HIGH PERFORMANCE DITEC™ BRAD POINT BORING

Application: New series of Ditec™ dowel drills with special grinding and high performance carbide for ultra long-lasting applications.

ØD	B	Tool No. - RH	Tool No. - LH	Ød	L
5mm	27mm	205005	305005	10mm	57mm
8mm	27mm	205008	305008	10mm	57mm
5mm	35mm	206005	306005	10mm	70mm
8mm	35mm	206008	306008	10mm	70mm

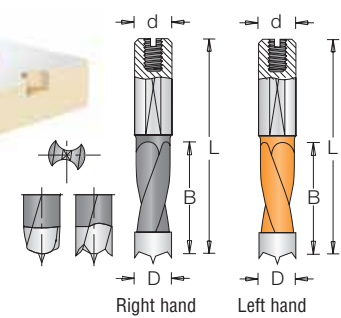

## † THINGE BORING

57mm LONG, 10mm SHANK, 2-WING W/SPURS

Application: Boring machines (10mm shank) and drill presses (3/8" shank)

ØD	Ød	Tool No. - RH	Tool No. - LH	L
15mm	10mm	203151	203155	57mm
16mm	10mm	203161	203165	57mm
18mm	10mm	203181	203185	57mm
20mm	10mm	203201	203205	57mm
22mm	10mm	203221	203225	57mm
25mm	10mm	203251	203255	57mm
26mm	10mm	203261	203265	57mm
28mm	10mm	203281	203285	57mm
30mm	10mm	203301	203305	57mm
32mm	10mm	203321	203325	57mm
35mm	10mm	203351	203355	57mm
38mm	10mm	203381	203385	57mm
40mm	10mm	203401	203405	57mm
3/4	10mm	203751	203755	57mm

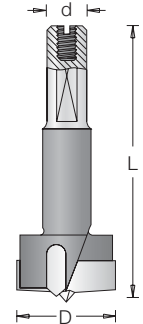
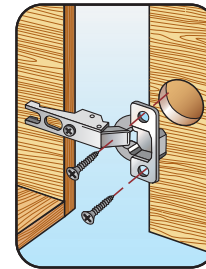

70mm LONG, 10mm SHANK, 2-WING W/SPURS

ØD	Ød	Tool No. - RH	Tool No. - LH	L
13mm	10mm	203132	203134	70mm
14mm	10mm	203142	203144	70mm
15mm	10mm	203152	203154	70mm
16mm	10mm	203162	203164	70mm
20mm	10mm	203202	203204	70mm
25mm	10mm	203252	203254	70mm
26mm	10mm	203262	203264	70mm
30mm	10mm	203302	203304	70mm
35mm	10mm	203352	203354	70mm
40mm	10mm	203402	203404	70mm
9/16	10mm	203146	203148	70mm
3/4	10mm	203752	203754	70mm



† Application: Not to be used in portable drills or handheld routers.

Wood profiles shown at actual size. 3D renderings & tool illustrations not shown at actual size.

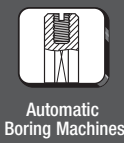

Automatic Boring Machines



Multi-Purpose Boring



Mortising & Slot Cutting



Countersinks/Counterbores

# Boring/Drilling



## †HINGE BORING

77mm LONG, 10mm SHANK, 2-WING W/SPURS

ØD	Ød	Tool No. - RH	Tool No. - LH	L
25mm	10mm	203256	203258	77mm
30mm	10mm	203306	203308	77mm
35mm	10mm	203356	203358	77mm

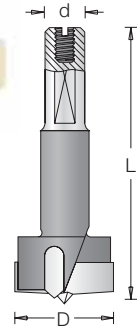

## 90mm LONG, 2-WING W/SPURS

ØD	Tool No. - Right Hand	Ød	L
16mm	203166	10mm	90mm
18mm	203186	10mm	90mm
22mm	203226	10mm	90mm
28mm	203286	10mm	90mm
35mm	203357	10mm	90mm
35mm	203359	3/8	90mm

## †HINGE BORING

10mm ROUND SHANK • 2-WING WITH SPURS

Application: Drill Presses Only / Metric European hinges.

ØD	Ød	Tool No.	L1	L
8mm	10mm	203008	30mm	90mm
10mm	10mm	203010	30mm	90mm
11mm	10mm	203011	30mm	90mm
12mm	10mm	203012	30mm	90mm
13mm	10mm	203013	30mm	90mm
14mm	10mm	203014	30mm	90mm
15mm	10mm	203015	30mm	90mm
16mm	10mm	203016	30mm	90mm
17mm	10mm	203017	30mm	90mm
18mm	10mm	203018	30mm	90mm
19mm	10mm	203019	30mm	90mm
20mm	10mm	203020	30mm	90mm
21mm	10mm	203021	30mm	90mm
22mm	10mm	203022	30mm	90mm
23mm	10mm	203023	30mm	90mm
24mm	10mm	203024	30mm	90mm
25mm	10mm	203250	30mm	90mm
26mm	10mm	203260	30mm	90mm
27mm	10mm	203027	30mm	90mm
28mm	10mm	203028	30mm	90mm
29mm	10mm	203029	30mm	90mm
30mm	10mm	203300	30mm	90mm
31mm	10mm	203031	30mm	90mm
32mm	10mm	203032	30mm	90mm
33mm	10mm	203033	30mm	90mm
34mm	10mm	203034	30mm	90mm
35mm	10mm	203350	30mm	90mm
36mm	10mm	203036	30mm	90mm
37mm	10mm	203037	30mm	90mm
38mm	10mm	203380	30mm	90mm
39mm	10mm	203039	30mm	90mm
40mm	10mm	203040	30mm	90mm

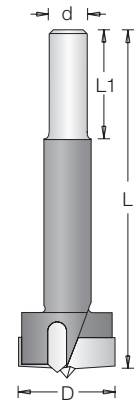

BORING/DRILLING

† Application: Not to be used in portable drills or handheld routers.

Wood profiles shown at actual size. 3D renderings & tool illustrations not shown at actual size.



# Boring/Drilling

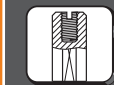

Automatic Boring Machines



Multi-Purpose Boring



Mortising & Slot Cutting



Countersinks/Counterbores

## †HINGE BORING

### 3/8" SHANK • 2-WING

Application: Drill presses only, right hand rotation. Economical alternative to other 35mm hinge bits.

ØD	Ød	Tool No.	L
35mm	3/8	<b>EB-351</b>	57mm

**NOTE:** Right hand tools rotate clockwise. Left hand tools rotate counter-clockwise.

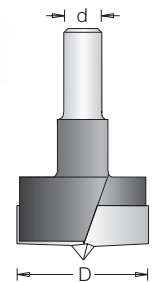

## †HINGE BORING FOR ROUTERS

### 60mm LONG, 1/2 SHANK, 2-WING (NO SPURS)

Application: Designed for high RPM (22,000) on plunge routers, CNC routers, machining centers and point-to-point machines.

ØD	Ød	Tool No.	L1	L
35mm	1/2	<b>203431</b>	30mm	60mm

**WARNING:** Maximum RPM  $\frac{28,000}{28} = 28,000$

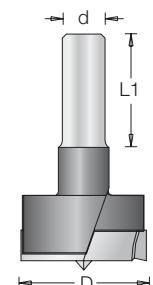

## †FRACTIONAL SIZE BORING

### 2 & 3 WING • WITH SPURS

Application: 1/2" shank for use in drill presses only.

ØD	Ød	Tool No.	L	Wings
1	1/2	<b>420108</b>	4	2
1-1/8	1/2	<b>420208</b>	4	2
1-1/4	1/2	<b>420308</b>	4	2
1-3/8	1/2	<b>420408</b>	4	2
1-1/2	1/2	<b>420508</b>	4	2
1-5/8	1/2	<b>420608</b>	4	2
1-3/4	1/2	<b>420708</b>	4	2
1-7/8	1/2	<b>420808</b>	4	2
2	1/2	<b>420908</b>	4	3
2-1/8	1/2	<b>420918</b>	4	3
2-1/4	1/2	<b>420998</b>	4	3

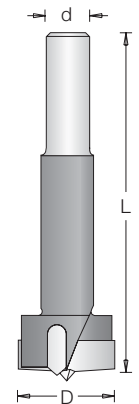

2-wing shown

## †METRIC COUNTERSINKS

### 2 FLUTE • CARBIDE-TIPPED

Application: Use with 10mm shank boring bits to drill and countersink for screws in one pass.

ØD	Ød	Tool No.- RH	Tool No.- LH	L
16mm	5mm	<b>316005</b>	<b>416005</b>	16.5mm
16mm	6mm	<b>316006</b>	<b>416006</b>	16.5mm
16mm	7mm	<b>316007</b>	<b>416007</b>	16.5mm
18mm	8mm	<b>316008</b>	<b>416008</b>	16.5mm
18mm	9mm	<b>316009</b>	<b>416009</b>	16.5mm
20mm	10mm	<b>316010</b>	<b>416010</b>	16.5mm
20mm	12mm	<b>316012</b>	<b>416012</b>	16.5mm

Replacement set screw #67087 (5mm only).

Replacement set screw #67079 (6mm to 12mm).

**NOTE:** Right hand tools rotate clockwise. Left hand tools rotate counter-clockwise.

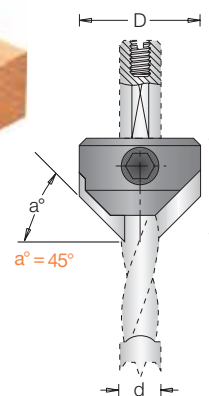

† Application: Not to be used in portable drills or handheld routers.



Automatic Boring Machines



Multi-Purpose Boring



Mortising & Slot Cutting



Countersinks/Counterbores

# Boring/Drilling



## †METRIC BORING DRILLS SOLID CARBIDE

Application: Boring machines for shelving hardware, etc. Use with adapters or bushings, shown below.

Ød & ØD	Tool No. - RD	Tool No. - LH	L
2mm	363002	463002	49mm
2.5mm	363025	463025	55mm
3mm	363003	463003	55mm
3.2mm	363032	463032	55mm
3.5mm	363035	463035	55mm
4mm	363004	463004	55mm
4.5mm	363045	463045	55mm
5mm	363005	463005	55mm

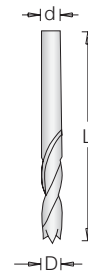

## †10mm SHANK DRILL ADAPTERS WITH RETAINING SCREW

Application: Use with solid carbide drills, shown above. For quick insertion and removal from chuck. (Can be used on left or right hand drills.)

ØD	Ød	Tool No.	L
2mm	10mm	364020	38mm
2.3mm	10mm	364023	38mm
2.5mm	10mm	364025	38mm
3mm	10mm	364030	38mm
3.2mm	10mm	364032	38mm
3.5mm	10mm	364035	38mm
4mm	10mm	364040	38mm
4.5mm	10mm	364045	38mm
5mm	10mm	364050	38mm
1/4"	10mm	364063	38mm

Replacement set screw #67092 (new style #10-24) or #67097 (old style 5x8mm).

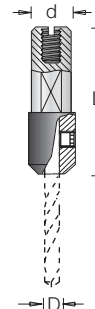

## †10mm SHANK DRILL BUSHINGS

Application: Use with solid carbide drills, shown above. Economical alternative to drill adapters. (Can be used on left or right hand drills.)

ØD	Ød	Tool No.	L
2mm	10mm	365020	23mm
2.5mm	10mm	365025	23mm
3mm	10mm	365030	23mm
3.2mm	10mm	365032	23mm
3.5mm	10mm	365035	23mm
4mm	10mm	365040	23mm
4.5mm	10mm	365045	23mm
5mm	10mm	365050	23mm

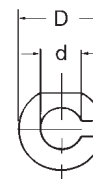

† Application: Not to be used in portable drills or handheld routers.

Wood profiles shown at actual size. 3D renderings & tool illustrations not shown at actual size.

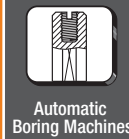

Automatic Boring Machines



Multi-Purpose Boring



Mortising & Slot Cutting



Countersinks/Counterbores

## †BORING MACHINE REPLACEMENT CHUCKS FOR 10mm SHANK BORING

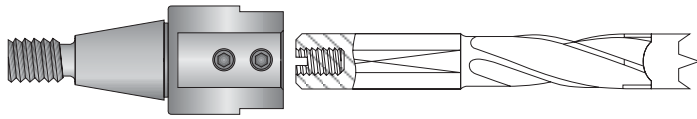

Application: Replace worn or damaged chucks. In stock for immediate delivery. Meets or exceeds O.E.M. specifications.

**Due to many different styles, please order carefully.**

### CHUCK FOR NOTTMAYER MACHINES

ØD	L1	Tool No.- RH	Tool No.- LH	M	Ød	L
19.5mm	15mm	310010	310105	8mm	10mm	40mm

#### STYLE 310

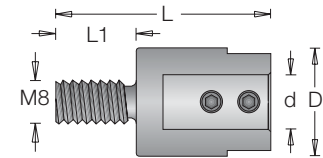

### CHUCK FOR TORWEGGE • AYEN MACHINES

ØD	L1	Tool No.- RH	Tool No.- LH	M	Ød	L
19.5mm	15mm	302010	302105	10mm	10mm	40mm

#### STYLE 302

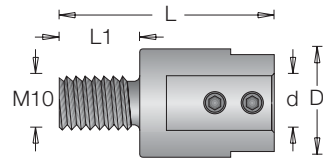

### CHUCK FOR BUSSELATTO • OMPEC MACHINES

ØD	L1	Tool No.- RH	Tool No.- LH	a°	M	Ød	L
19.5mm	11mm	303010	303105	30°	10mm	10mm	46mm

#### STYLE 303

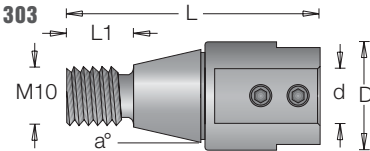

### CHUCK FOR BILEK MACHINES

ØD	L1	Tool No.- RH	Tool No.- LH	a°	M	Ød	L
19.3mm	11mm	304010	304105	20.8°	8mm	10mm	48mm

#### STYLE 304

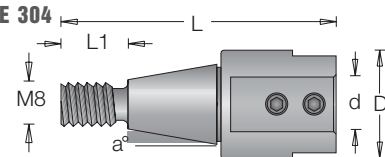

### CHUCK FOR HOLZ-HER • S.C.M.I. • MORBIDELLI • BIESE REIMALL • VITAP • WEEKE MACHINES

ØD	L1	Tool No.- RH	Tool No.- LH	M	Ød	L
19.5mm	16mm	305010	305105	10mm	10mm	41mm

#### STYLE 305

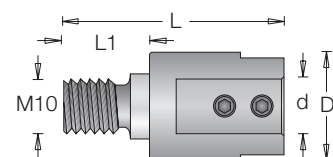

### CHUCK FOR • MORBIDELLI • NOTTMAYER MACHINES

ØD	L1	Tool No.- RH	Tool No.- LH	M	Ød	L
19.3mm	15mm	358010	358105	8mm	10mm	41mm

#### STYLE 358

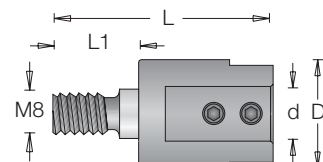

### CHUCK FOR SCHEER MACHINES

ØD	L1	Tool No.- RH	Tool No.- LH	M	Ød	L
19.5mm	—	359010	359105	10mm	10mm	42mm

#### STYLE 359

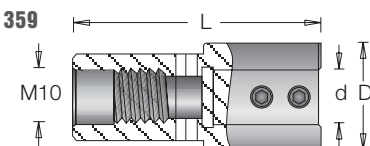

**NOTE:** Right hand tools rotate clockwise. Left hand tools rotate counter-clockwise.

† Application: Not to be used in portable drills or handheld routers.

Wood profiles shown at actual size. 3D renderings & tool illustrations not shown at actual size.





Automatic Boring Machines



Multi-Purpose Boring



Mortising & Slot Cutting



Countersinks/Counterbores

# Boring/Drilling



## ROSETTE CUTTER SYSTEM CARBIDE TIPPED

The only Rosette Cutter featuring replaceable carbide tipped insert knives. Fifteen different standard knife profiles available along with three sizes of blank knives for custom grinding.

The only Rosette Cutter with an optional shaper cutter head to make matching moldings.

Precision balanced for high speed operation on a heavy-duty drill press, milling machine, lathe or shaper. All cutter bodies are manufactured using the highest quality tool steel.

The Rosette Cutter works well in softwoods, hardwoods, MDF and solid surface materials such as Corian®, Gibraltar®, Surell®, etc.

### BLANK CARBIDE TIPPED KNIVES:

- 59500 1-3/16" width
- 59510 1-1/2" width
- 59520 1-15/16" width

### Accessories/Parts:

- Special 1" x 3/4" shaper cutter bushing - #59700
- Replacement 3mm hex key - #5008
- Replacement special screw - #67008 (6 required)
- Replacement 1/2" shank arbor only - #59702

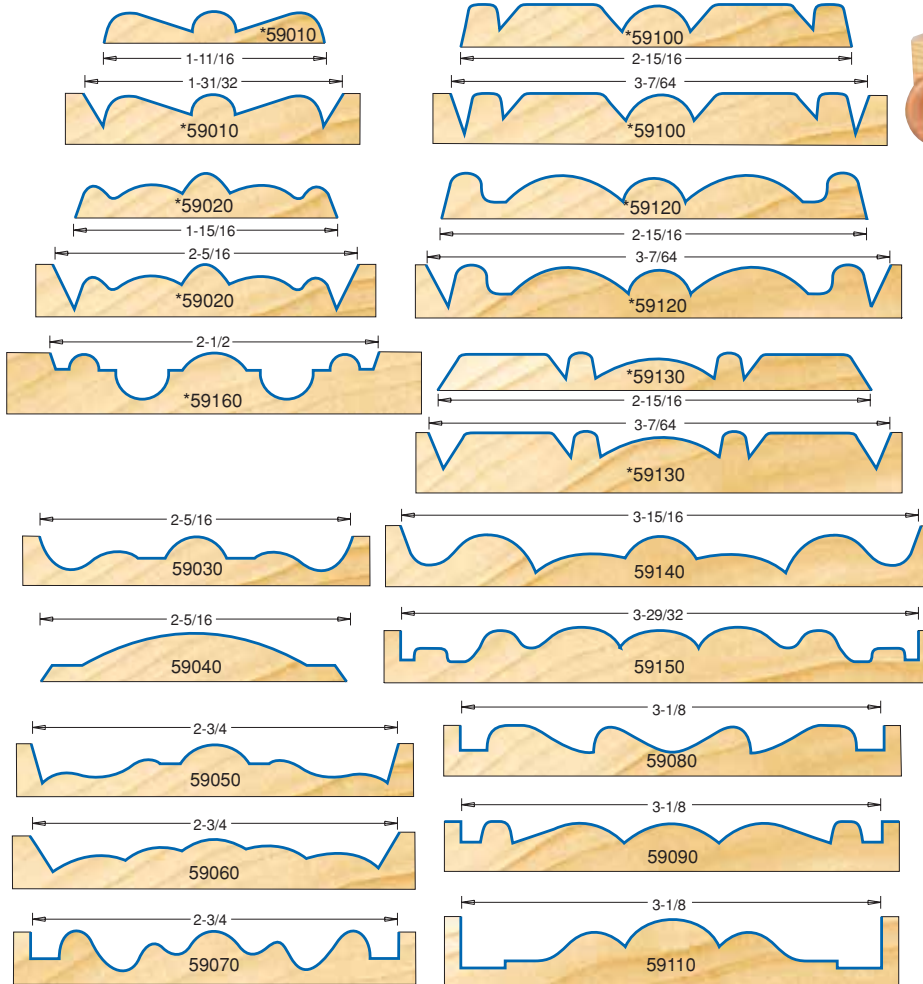

(Wood profiles not at actual size)

### COMPLETE ROSETTE CUTTER SYSTEM

#### Important Ordering Instructions:

- 1) Select the desired product number for either the Rosette cutterhead, shaper head, or both.
- 2) Knives must be ordered separately and you must order two of each of the selected knife for proper operation.
- 3) The Rosette cutterhead is designed to be used with a heavy-duty drill press, milling machine or lathe. Do not attempt to use this product in a light-duty drill press, portable electric drill or router.
- 4) Suggested initial speed for a drill press, etc., is 800 RPM with a slow feed rate. Increase RPM if tool is cutting too slowly. Conversely, if burning occurs, decrease RPM.
- 5) Maximum RPM 5000 (Rosette cutter) and 10,000 (shaper cutterhead only).

\* These knife patterns will cut either a standard recessed rosette or a rosette "button". (See photo and illustrations.)

**NOTE: All knives are sold individually. Two of each knife are required for proper operation.**

### SET NO. 59000

Includes:  
3-1/8" diameter Rosette Cutter (1/2" shank).  
3-3/4" dia. shaper cutterhead (1" bore) hex key & custom wood box. Order knives separately.



Knives not included in set.

### SET NO. 59004

Includes:  
3-1/8" diameter Rosette Cutter (1/2" shank) hex key & custom wood box. Order knives separately.



Knives not included in set.

### NO. 59002

Includes:  
3-3/4" diameter shaper cutter only (1" bore). Order knives separately.



Knives not included.

Wood profiles shown at actual size. 3D renderings & tool illustrations not shown at actual size.

# Boring/Drilling



Automatic Boring Machines



Multi-Purpose Boring



Mortising & Slot Cutting



Countersinks/Counterbores

## CARBIDE-TIPPED COUNTERSINK FOR WOOD SCREWS / 2-WING

Wood Screw Size	ØD	ØD1	B	Ød	Tool No.	L1	L	Replacement Drill Bit
#4	11/32	3/32	1/2	5/16	55200	1-5/8	2-1/4	630-002
#4	3/8	7/64	1/2	5/16	55201	1-5/8	2-3/8	630-098
#6	5/16	1/8	1/2	5/16	55203	1-5/8	2-9/16	630-102
#6	3/8	1/8	1/2	5/16	55202	1-5/8	2-9/16	630-102
#6	1/2	1/8	1/2	5/16	55205	1-5/8	2-9/16	630-102
#6	25/64	9/64	1/2	5/16	55204	1-5/8	2-3/4	630-802
#8	25/64	5/32	1/2	5/16	55206	1-5/8	2-7/8	630-202
#8	7/16	11/64	1/2	5/16	55208	1-5/8	3	630-302
#10	7/16	3/16	1/2	3/8	55210	1-3/4	3	630-402
#10	1/2	3/16	1/2	3/8	55211	1-3/4	3	630-402
#12	15/32	7/32	1/2	3/8	55212	1-3/4	3	630-502
#12	1/2	7/32	1/2	3/8	55213	1-3/4	3	630-502
#14	1/2	15/64	1/2	3/8	55214	1-3/4	3	630-602
#14	1/2	1/4	1/2	3/8	55215	1-3/4	3	630-702
#14	17/32	1/4	1/2	3/8	55216	1-3/4	3	630-702

Replacement set screw #67083.

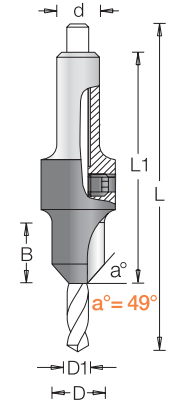
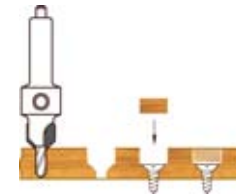

## CARBIDE-TIPPED COUNTERSINKS WITH TAPER POINT DRILL FOR WOOD SCREWS / 2-WING

**New**

Wood Screw Size	ØD	ØD1	B	Ød	Tool No.	L1	L	Replacement Drill Bit
#4	11/32	3/32	1/2	5/16	55600	1-1/2	2-1/4	630-262
#6	3/8	1/8	1/2	5/16	55602	1-5/8	2-9/16	630-266
#6	25/64	9/64	1/2	5/16	55604	1-5/8	2-3/4	630-268
#8	7/16	11/64	1/2	5/16	55608	1-5/8	2-7/8	630-272
#10	7/16	3/16	1/2	3/8	55610	1-3/4	3	630-274

Replacement set screw #67083.

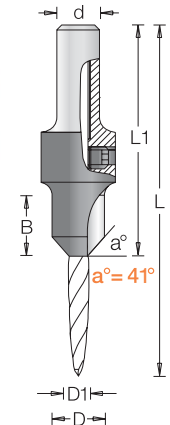
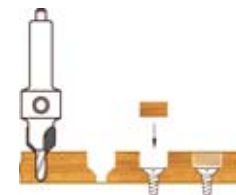

## 'DI-COUNT'™ ADJUSTABLE COUNTERSINK

Accepts Drills\* from 3/32" through 9/32"  
(Wood Screw Sizes #2 through #18.)

### CARBIDE-TIPPED / 2-WING

ØD	a°	Tool No.	B	Ød	L
7/16-19/32	45°	20200	7/16	3/32-9/32	1-1/4

Replacement allen screws (2 required) #67090.

Replacement 3mm hex key #5004.

\*Drills not included.

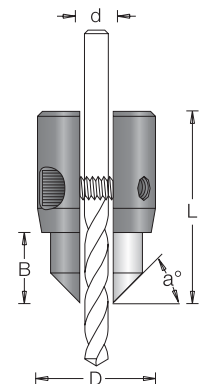

SEE QUICK CHANGE TYPE COUNTERSINKS ON PAGE 174.

BORING/DRILLING



Automatic Boring Machines

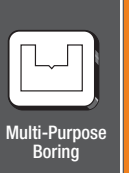

Multi-Purpose Boring

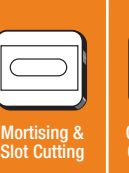

Mortising & Slot Cutting



Countersinks/Counterbores

# Boring/Drilling



## PLUG CUTTER FOR ROUTERS

1/2" SHANK • CARBIDE-TIPPED • 2 FLUTE

ØD	ØD1	B	Tool No.	Ød	L
5/8	3/8	1/2	55220	1/2	2-1/2
25/32	1/2	1/2	55222	1/2	2-1/2
29/32	5/8	1/2	55224	1/2	2-1/2

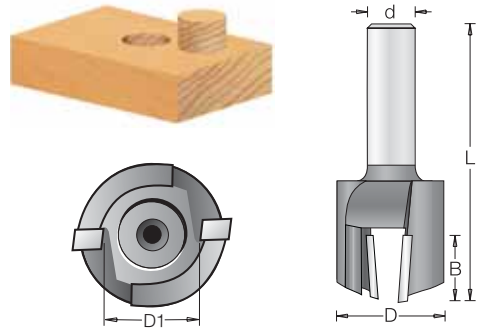

## CARBIDE TIPPED COUNTERSINK & PLUG SET

10MM DIAMETER COUNTERSINK & PLUG

- Drilling & Countersinking with a single tool.
- Concealing of screwheads with plugs which perfectly fit with countersink.
- Designed for portable drills and drill presses.

Drill Dia.	Tool No.	Description
1/8"	PS-100	2 Pc. Countersink & Plug Cutter
9/64"	PS-200	2 Pc. Countersink & Plug Cutter
5/32"	PS-300	2 Pc. Countersink & Plug Cutter
11/64"	PS-400	2 Pc. Countersink & Plug Cutter
—	PS-500	All 4 Countersinks & drills & 1 Plug Cutter
—	PLC-100	Plug Cutter only (10mm dia.)

**NOTE:** All countersinks are carbide-tipped. The plug cutter and drill bits are high-speed steel. Countersinks have 8mm shank diameter.

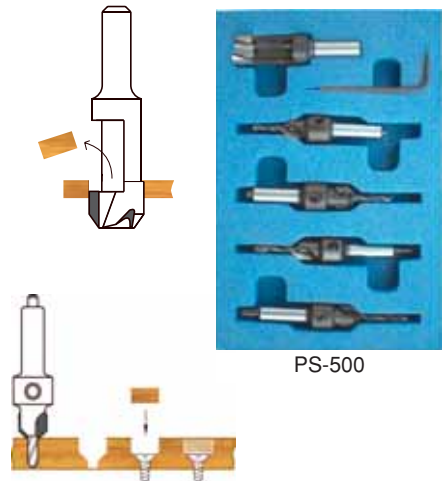

BORING/DRILLING

## RTA FURNITURE DRILL/COUNTERSINK

Commonly used for RTA (ready-to-assemble) furniture fittings. Specially-treated high-speed steel countersink with polished slow-spiral drill bit. Will perform 3 tasks in one: pilot hole, clearance hole and countersink.

ØD	ØD1	ØD2	B	Tool No.	B1	Ød	L
3.5mm	5.0mm	7.0mm	15.0mm	55102	5.0mm	10mm	80mm
5.0mm	7.0mm	10.0mm	15.0mm	55103	5.0mm	10mm	90mm

- Replacement 3.5mm HSS slow spiral drill bit, 2-3/4" long, #55104.
- Replacement 5.0mm HSS slow spiral drill bit, 3-7/16" long, #55105.
- Replacement #10-24 set screw, #67092 (requires #5000 3/32" hex key).

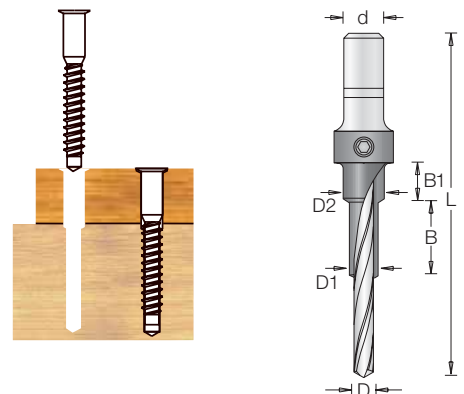

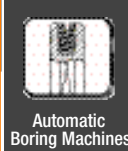

Automatic Boring Machines



Multi-Purpose Boring



Mortising & Slot Cutting



Countersinks/Counterbores

## QUICK RELEASE ACCESSORIES

### QUICK CHANGE CHUCK

Simply pull sleeve to change drill bits, screwdrivers, countersinks and other power bits. Special long shaft for use with keyless chucks. This is an industrial quality accessory manufactured with exacting tolerances.

Ød	Tool No.	L
3/8	55298	2

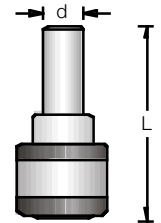

### CARBIDE TIPPED COUNTERSINKS

Drill pilot hole and tapered countersink for wood screws. Carbide tipped for long lasting results in hardwood, plywood, plastics, etc.

Wood				Tool No.	Ød	L	Replacement Drill Bit
ØD	ØD1	Screw Size	a°				
3/8	5/64	#4	49°	55260	1/4	2-1/8	630-001
3/8	3/32	#6	49°	55262	1/4	2-1/8	630-002
3/8	7/64	#8	49°	55264	1/4	2-1/8	630-098
3/8	1/8	#10	49°	55266	1/4	2-1/8	630-102
1/2	9/64	#12	49°	55268	1/4	2-1/8	630-802
1/2	5/32	#12-#14	49°	55269	1/4	2-1/8	630-202

Replacement set screw #67083. Hex key #5009.

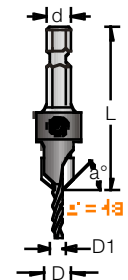
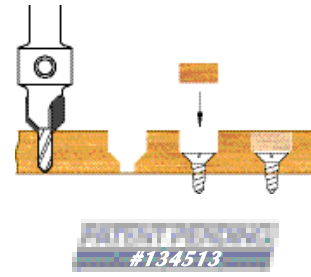

### CARBIDE TIPPED COUNTERSINKS WITH TAPER POINT DRILL

**New**

Drill pilot hole and tapered countersink for wood screws. Carbide tipped for long lasting results in hard wood, plywood, plastics, etc.

Wood				Tool No.	Ød	L	Replacement Drill Bit
ØD	ØD1	Screw Size	a°				
3/8	5/64	#4	41°	55620	1/4	2-1/8	630-260
3/8	3/32	#6	41°	55622	1/4	2-1/8	630-262
3/8	7/64	#8	41°	55624	1/4	2-1/8	630-264
3/8	1/8	#10	41°	55626	1/4	2-1/8	630-266
1/2	9/64	#12	41°	55628	1/4	2-1/8	630-268
1/2	5/32	#12-#14	41°	55630	1/4	2-1/8	630-270

Replacement set screw #67083. Hex key #5009.

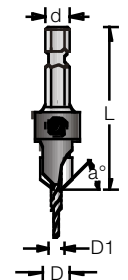
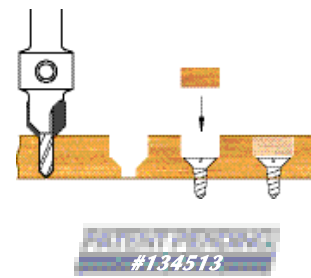

### CARBIDE TIPPED COUNTERBORES

Flat bottom counterbores for using round head screws, hex bolts, etc. Includes pilot drill.

ØD	ØD1	Ød	Tool No.	L	Replacement Drill Bit
3/8	5/32	1/4	55280	2-3/16	630-202
3/8	3/16	1/4	55282	2-3/16	630-402
1/2	3/16	1/4	55284	2-3/4	630-402
1/2	1/4	1/4	55286	2-3/4	630-702
5/8	1/4	1/4	55288	2-3/4	630-702

Replacement set screw #67083. Hex key #5009.

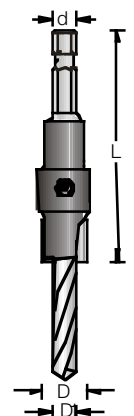
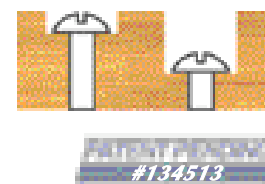



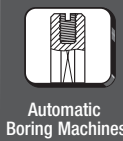

Automatic Boring Machines



Multi-Purpose Boring



Mortising & Slot Cutting



Countersinks/Counterbores

# Boring/Drilling

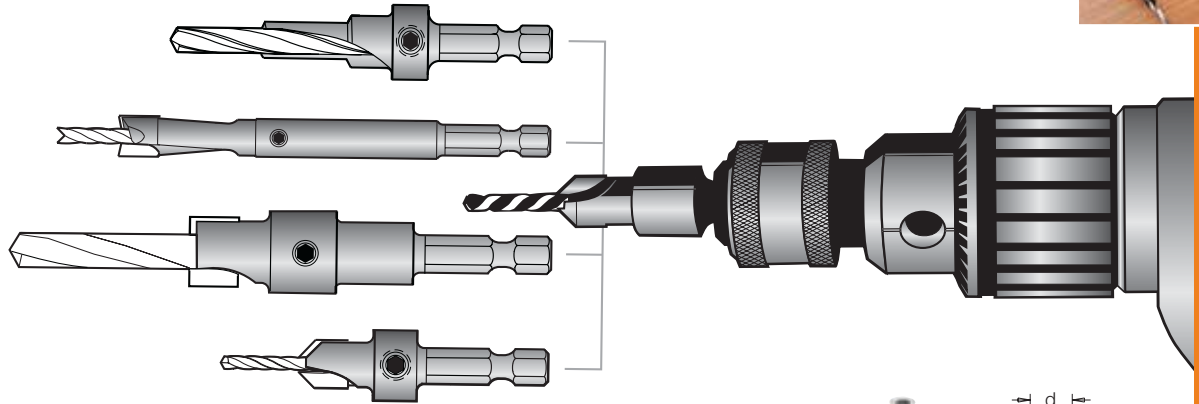

## RTA FURNITURE DRILL/COUNTERSINK

RTA furniture step drill. Used for drilling pilot hole, clearance hole and countersinking.

ØD	ØD1	ØD2	Ød	Tool No.	B	B1	L
3.5mm	5.0mm	7.0mm	1/4	55290	15.0mm	5.0mm	52.0mm
5.0mm	7.0mm	10.0mm	1/4	55292	15.0mm	5.0mm	90.0mm

Replacement 3.5mm HSS slow spiral drill bit, 2-3/4" long, #55104.  
 Replacement 5.0mm HSS slow spiral drill bit, 3-7/16" long, #55105.  
 Replacement #10-24 set screw, #67092 (requires #5000 3/32 hex key).

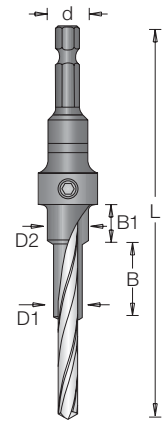
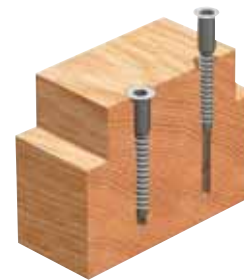

## CARBIDE TIPPED COUNTERBORES FOR FACE FRAME MACHINES W/QUICK SHANK

ØD	Type	Description	Tool No.	ØD1	Ød	L
3/8	1	Counterbore/drill for face frame machines	55270	.136	1/4	4
—	—	#29 replacement HSS fish tail drill	424004	.136	—	2-7/8
—	—	8-32 NC set screw	67010	—	—	—

## †CARBIDE TIPPED COUNTERBORES FOR FACE FRAME MACHINES

Application: Features include precision ground carbide-tipped counterbore for splinter-free cutting, non-slip surface treatment for positive clamping, wide web design for superior strength and replaceable HSS fishtail drills. Available for face frame machines (type 1) and drill presses (type 2). Type 1 will fit Evans, Ritter, Unique, Marcon and Norfield face frame machines.

ØD	Type	Description	Tool No.	ØD1	Ød	L
3/8	1	Counterbore/drill for face frame machines	424000	.136	3/8	4
3/8	2	Counterbore/drill for drill presses	424002	.136	3/8	6
—	—	#29 replacement HSS fishtail drill	424004	.136	—	2-7/8
—	—	8-32 NC set screw	67010	—	—	—

† Application: Not to be used in portable drills or handheld routers.



BORING/DRILLING

# Boring/Drilling



Automatic Boring Machines



Multi-Purpose Boring



Mortising & Slot Cutting



Countersinks/Counterbores

## FORSTNER PATTERN SETS HIGH CARBON TOOL STEEL

All sets are packed in beautiful, custom-made hardwood cases. Features a sliding, clear acrylic door with sizes imprinted on the front and a pre-drilled bit tray that rotates for easy access to your tools.



Set No. FO-700



Set No. FO-600

### 3/8" SHANK

Description	Order #
6-Piece Forstner bit set, 3/8" shank. Sizes: 3/8, 1/2, 5/8, 3/4, 7/8, 1.	<b>FO-600</b>
15-Piece Forstner bit set, 3/8" shank. Sizes: All 15 fractional sizes. (3/8 through 2-1/8 in 1/8 increments.)	<b>FO-700</b>

## MULTI-TOOTH FORSTNER BITS

Specially designed Forstner bits for cutting telephone and computer wire grommet access holes in office furniture. All tools feature precision ground and tempered tool steel, multi-tooth cutting edges for faster cutting and chip removal, and massive cutter body to dissipate heat and resist burning.

### 1/2" SHANK HIGH CARBON TOOL STEEL

ØD	Tool No.	Ød	L
2-1/8 (54mm)	<b>FO-546</b>	1/2	6
2-1/4 (57mm)	<b>FO-558</b>	1/2	6
2-3/8 (60mm)	<b>FO-562</b>	1/2	6
3 (76mm)	<b>FO-574</b>	1/2	6
3-1/8 (80mm)	<b>FO-560</b>	1/2	6

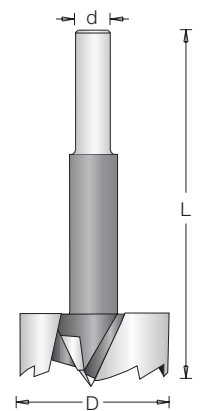

BORING/DRILLING

## FORSTNER PATTERN BITS

Application: Drill pocket-holes, flat-bottom holes\*, etc., using any 3/8" or larger portable drill or stationary drill press. Forstner pattern bits are well known for their ability to drill clean and chip-free holes in wood. Amana Tool® uses only the finest quality tool steel, precision machined and ground on state-of-the-art equipment. Large gullets milled in the tool body provide exceptional chip clearance.

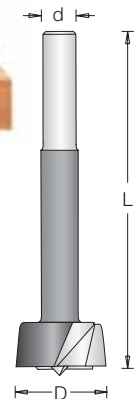

### 2 WING HIGH CARBON TOOL STEEL

ØD	Ød	Tool No.	L	ØD	Ød	Tool No.	L
1/4	5/16	<b>FO-080</b>	3-1/2	1	3/8	<b>FO-254</b>	3-1/2
3/8	3/8	<b>FO-095</b>	3-1/2	1-1/16	3/8	<b>FO-269</b>	3-1/2
5/16	3/8	<b>FO-079</b>	3	1-1/8	3/8	<b>FO-285</b>	3-1/2
7/16	3/8	<b>FO-111</b>	3-1/2	1-1/4	3/8	<b>FO-317</b>	3-1/2
1/2	3/8	<b>FO-127</b>	3-1/2	1-3/8	3/8	<b>FO-349</b>	3-1/2
9/16	3/8	<b>FO-142</b>	3-1/2	35mm	3/8	<b>FO-350</b>	3-1/2
5/8	3/8	<b>FO-160</b>	3-1/2	1-1/2	3/8	<b>FO-381</b>	3-1/2
11/16	3/8	<b>FO-174</b>	3-1/2	1-5/8	3/8	<b>FO-413</b>	3-1/2
3/4	3/8	<b>FO-190</b>	3-1/2	1-3/4	3/8	<b>FO-445</b>	3-1/2
13/16	3/8	<b>FO-206</b>	3-1/2	1-7/8	3/8	<b>FO-476</b>	3-1/2
7/8	3/8	<b>FO-222</b>	3-1/2	2	3/8	<b>FO-508</b>	3-1/2
15/16	3/8	<b>FO-238</b>	3-1/2	2-1/8	3/8	<b>FO-540</b>	3-1/2

\*NOTE: A small pilot hole used for centering will be present on flat bottom holes.